



V300

COMMERCIAL VINYL SERIES









Single Hung | Horizontal Slider | Fixed

 **Product Material**
Vinyl

 **Frame Depth**
3 1/4"

 **Rating**
Single Hung: CW50
Slider: CW50
Fixed: CW50



 Design Pressure Single Hung: 50 Slider: 50 Fixed: 50	 U-Value Single Hung: as low as 0.25 Slider: as low as 0.25 Fixed: as low as 0.23
 Air Infiltration Single Hung: <.30 Slider: <.30 Fixed: <.30	 SHGC Single Hung: as low as 0.21 Slider: as low as 0.21 Fixed: as low as 0.23
 Water Resistance Single Hung: Up to 7.52 Slider: Up to 7.52 Fixed: Up to 7.52	 CRF Single Hung: 81 Slider: 81 Fixed: 90
 OITC^x Single Hung: Slider: Fixed:	 STC^x Single Hung: Slider: Fixed:
<small>^x-All sound tests pending as of 11-2022</small>	

FEATURES:

- ▶ Extruded, architectural grade vinyl frame
- ▶ 1" insulating glass
- ▶ Continuous frame capabilities
- ▶ Side load single hung with Class 5 Block & Tackle balancers (up to 100 lb. sash)
- ▶ White vinyl
- ▶ Optional painted exterior (meets FGIA 615 finish)
- ▶ Textured laminate options for exterior and interior
- ▶ Use up to 8 floors with nail fin, up to 11 floors with receptor/subsill system

www.QuakerCommercialWindows.com

Information listed is deemed accurate as of date shown. Quaker Windows reserves the right to change or discontinue any product, feature or option without notice.

November, 2022 V3



V300

COMMERCIAL VINYL SERIES

Single Hung (CW50)

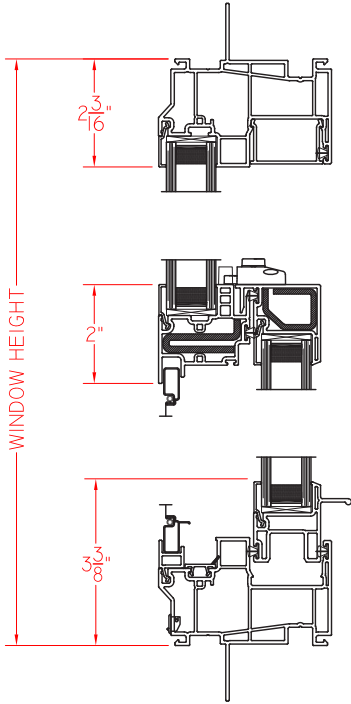

Horizontal Slider (CW50)

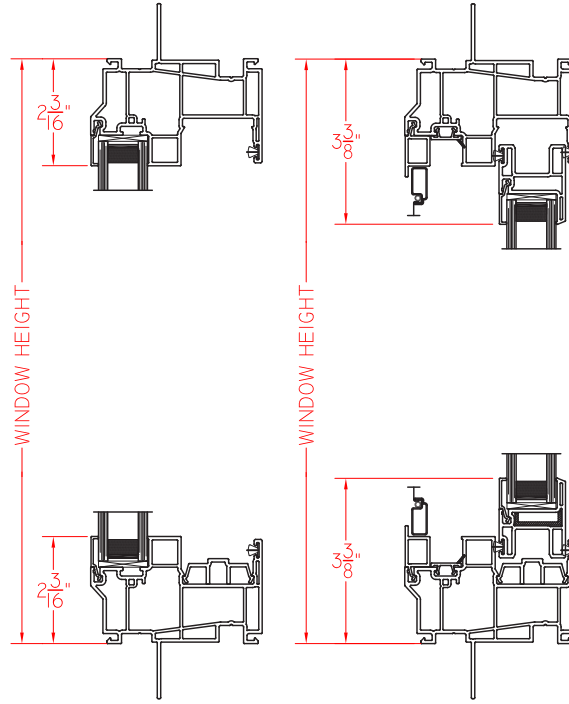

Fixed (CW50)

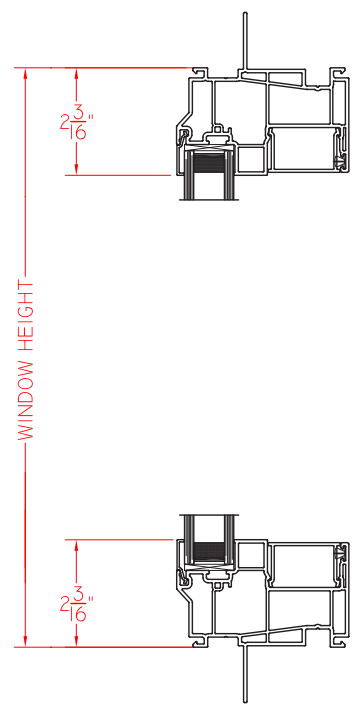

QuakerCommercialWindows.com
1-800-347-0438
Commercial@quakerwindows.com